



VEHICLES



AEROSPACE



GEARS & BEARINGS



ENGINEERING



WIND ENERGY

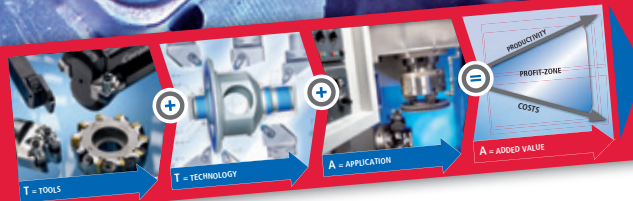

PCBN FOR CAST IRON MACHINING

Cutting materials and inserts for turning, grooving and milling

AEROSPACE

The aerospace industry places extremely high demands on machining. In this field, machining capacity and process safety are the decisive parameters, and our CSA cutting materials together with our Monsoon Tool Technology tools are the optimal solution. Component examples: Jet engine components such as blisks



AUTOMOTIVE INDUSTRY

For over 50 years, precision tools from CeramTec have been an integral part of highly productive machining solutions for components from the automotive industry. With our tool solutions, the implementation of concrete cost savings and increased productivity is always top priority. Component examples:

Brake discs, gear components, fly wheels, clutch plates, brake components, drive shafts, hydraulic elements, engine/motor components



MACHINERY AND PLANT ENGINEERING

Manufacturing complex components made of different materials with extreme precision and optimal surface quality in an economic way – that is the basic structure of requirements for which we work together with our customers to create innovative, cost-efficient machining solutions. Component examples: Gearbox housing, flanges, guides, shafts, rollers

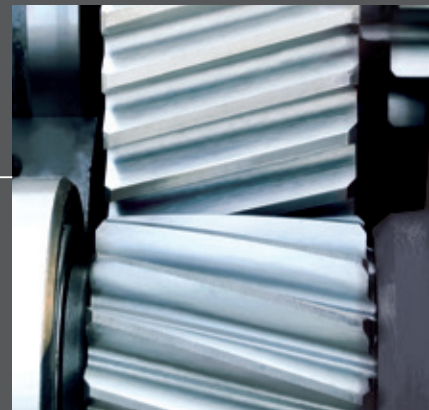

WIND ENERGY

In the field of wind energy, components mostly require special machining solutions, since the components involved are often especially large. Strict tolerance requirements and a high level of surface quality place extreme demands on the cutting materials and tool holders. By observing and analysing the determining factors for machining, we are able to provide our customers with extremely efficient and cost-effective machining solutions. Component examples: Rotor flange, rotor blade connections, planetary gear holders, gearbox housing, gear components

GEAR TECHNOLOGY, DRIVE TECHNOLOGY AND BEARING INDUSTRY

Surface quality, tolerances and the tool life of the cutting materials are the standards for quality for hard machining. Our unique range of cutting materials made of PcBN and ceramic, together with our perfectly matched tools, set the bar in this industry. In practice, this results in highly efficient and cost-effective machining.

Component examples: Gear wheels, shafts, large gearbox components, bearing rings and rolling elements

VEHICLE MANUFACTURING INDUSTRY

MOTOR INDUSTRY

The high-performance materials that are used in this industry require cutting materials that ensure an extremely high level of process reliability and a consistently high quality level. Our cutting materials and tools are the perfect solution.

Component examples: Connecting rods, pulley wheels, cylinder heads, cylinder liners

TRANSPORT

When machining components for the transport industry, special solutions are often required in order for the machining process to remain economic and efficient. Our tools and cutting materials make these kinds of solutions possible.

Component examples: Wheel rims, shafts, bearings

AGRICULTURAL AND CONSTRUCTION MACHINERY

We offer highly efficient bearing solutions for components for agricultural and construction machinery. Our range of solutions are currently used for machining of soft steel as well as processing cast iron and hardened parts.

Component examples: Brake components, drive shafts, hydraulic elements, motor components

AUTOMOTIVE

For over 50 years, precision tools from CeramTec have been an integral part of highly productive machining solutions for components from the automotive industry:

Component examples: Brake discs, brake drums, fly wheels, connecting rods, gear components, engine blocks



Motor industry



Transport



Agricultural and construction machinery



Automotive

Machining cast iron materials

The machining of cast iron materials is characterised by high cutting values in order to achieve the highest possible machining capacity. It allows for a significant reduction in machining costs and a substantial increase in productivity. The continuous development of cast iron, however, is placing greater demands on the cutting material, the efficiency and the process reliability of high performance machining.

The complete tool system – the cutting material, cutting edge geometry, clamping system and the tool holder – must accommodate the high machining forces and the strong thermal, chemical and abrasive loads that occur

during high-performance machining, while ensuring process reliability.

Other general conditions of production, corresponding to end user expectations, include a high-precision delivery at a reasonable price in the desired quality. A machining process that is technically optimised for maximum efficiency is therefore essential:

The goal is to incorporate not only the appropriate high-performance tool systems, but also high-end machining technology, comprehensive application know-how and fine-tuned tool logistics into the machining procedure.

With its extensive product and service port-

folio, SPK Cutting Tools – known as “SPK+ The Productivity Experts” – is rising to this challenge. The machining process is tailored to customer requirements and is perfected in its entirety; from the edges and technology used to machine application and tool logistics.



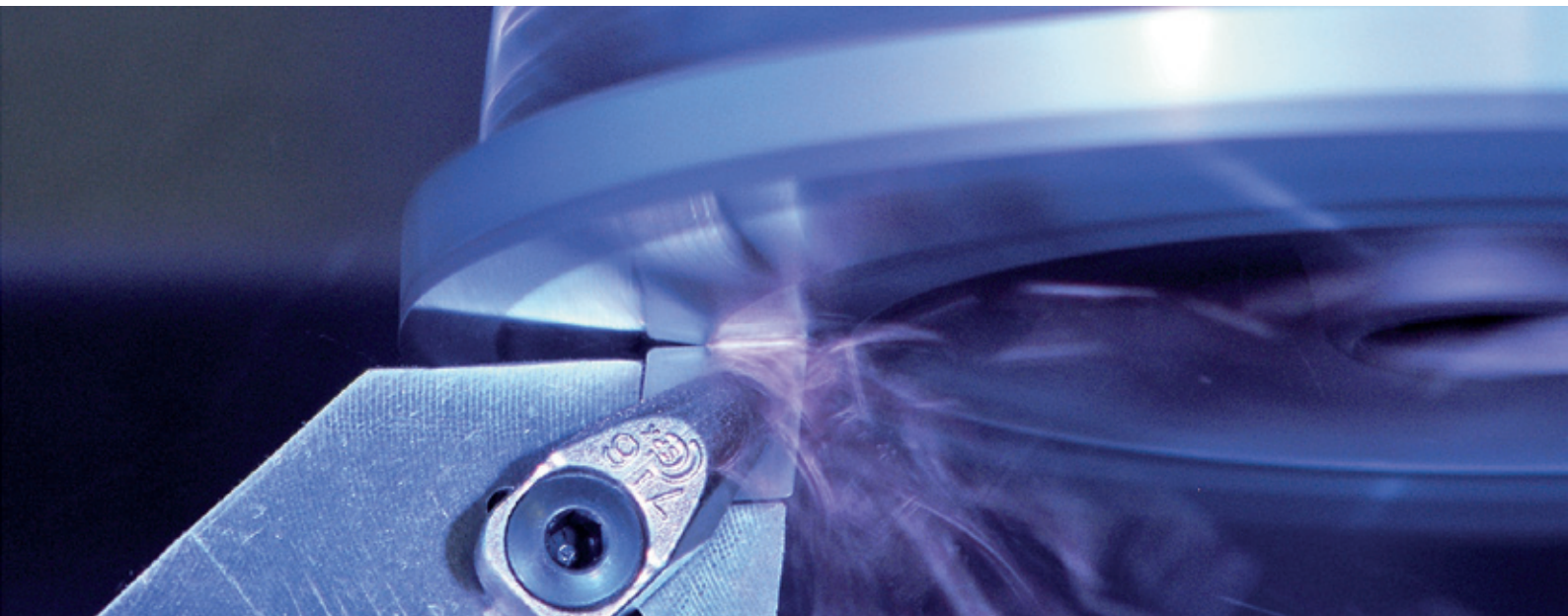

Technical Information	6 - 13
SPK Designation System for Inserts for Turning	16 - 17
SPK-PCBN Inserts for Turning	18 - 31
SPK Designation System for Inserts for Grooving	34 - 35
SPK-PCBN Inserts for Grooving	36 - 37
SPK Designation System for Inserts for Milling.....	40 - 41
SPK-PCBN Inserts for Milling	42

SPK PCBN CUTTING MATERIALS FOR HPC TURNING OF CAST IRON

The unique and comprehensive range of PCBN high-performance cutting materials allows for the reliable HPC machining of cast iron workpieces. The materials are set-

ting new standards with their superb wear characteristics during both continuous and interrupted cuts as well as their impressive performance in terms of red hardness, com-

pressive strength and chemical stability. The cutting materials are also available with a coating for wear recognition upon request.

SPK PCBN GRADES

WBN 101

This grade is ideal for turning and milling. Its extreme toughness and top wear characteristics make it possible to achieve high cutting values with continuous and interrupted cuts.

WBN 115

The high-performance machining specialist. Outstanding thermal stability combined with optimal toughness result in exceptional wear resistance for HPC machining. This grade achieves exceptional results thanks to its high edge stability and excellent wear resistance, particularly when roughing.

WBN 120

These two solid PCBN grades are suitable for roughing grey cast iron materials with moderate cutting data.

WBN 750

The multi-tipped or laminated PCBN variant is intended for finishing and boring grey cast iron materials.

i SPK PCBN grades for cast iron

WBN 101 • WBN 115 • WBN 120 • WBN 750

Cutting material	Material groups		
	GJL (grey cast iron)	Alloyed GJL (grey cast iron)	Chilled cast iron
WBN 101	●	●	○
WBN 115	●	●	●
WBN 120	●	○	●
WBN 750	●	●	●

● = Main application, ○ Additional applications

CUTTING DATA RECOMMENDATIONS FOR CAST IRON MACHINING

For cast iron (GJL)

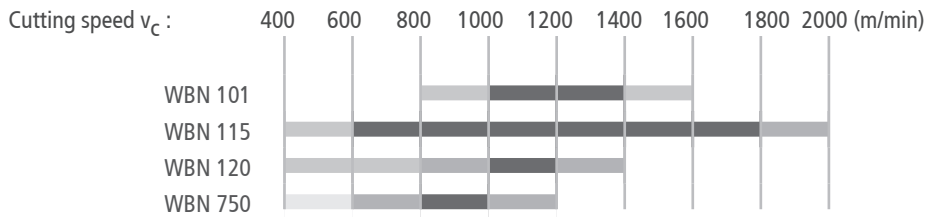



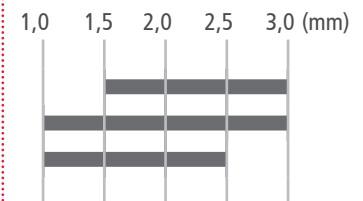
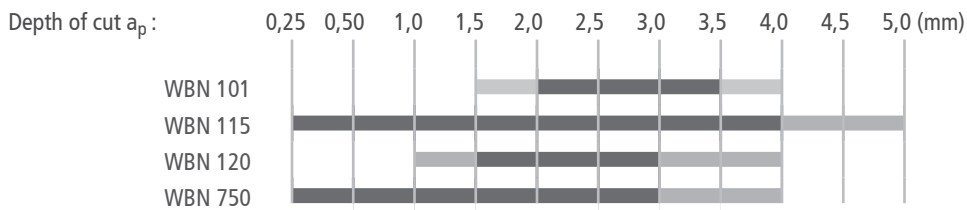
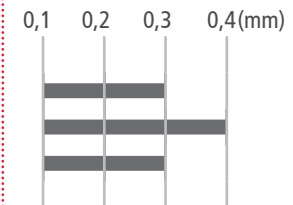
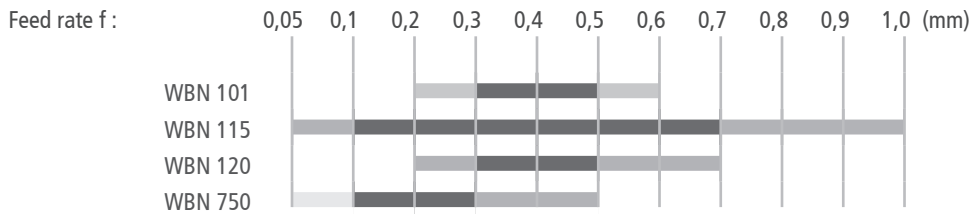
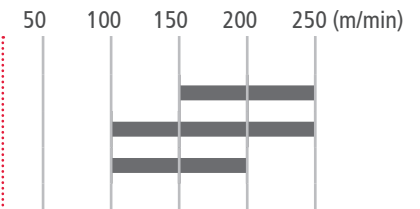



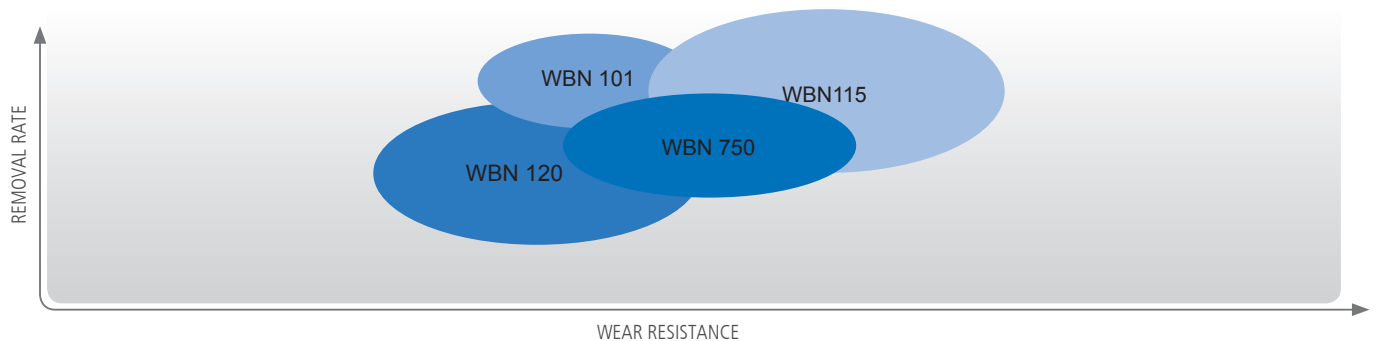

For chilled cast iron



MACHINING CAPACITY



TYPES OF SPK PCBN INSERTS ACCORDING TO ISO 1832

Symbol	Illustration	Description	SPK PCBN grades
B		One-side, multi-tipped PCBN inserts, 2 corners	WBN 750
C		One-side, multi-tipped PCBN inserts, 3 corners	
D		One-side, multi-tipped PCBN inserts, 4 corners	
F		PCBN one-side full face laminated	
L		Two-side, multi-tipped PCBN inserts, 4 corners	
M		Two-side, multi-tipped PCBN inserts, 6 corners	
N		Two-side, multi-tipped PCBN inserts, 8 corners	
S		PCBN solid	WBN 101, WBN 115, WBN 120

DESIGNATION SYSTEM FOR SPK PCBN INSERTS

with ZZ geometry

Number of cutting edges ——— Length of PCBN insert > 2 mm
CNGA 120408 T - LL 95Z025
 Chamfer design ——— Approach angle
 ——— Width of the ZZ chamfer

with IKS-PRO clamping system

————— Solid
CNGX 120408 T - S - DO
 Chamfer design ——— Insert with IKS-PRO notch
 clamping

IKS-PRO

High machining capacities in various cast iron materials also demand maximum performance from the tools. The IKS-PRO tool system is designed based on the requirements of high-performance processing. Combined with our ceramic and PCBN cutting materi-

als, they make an unbeatable team when it comes to high-performance machining. The patented notch geometry of IKS-PRO, the revolutionary clamping system, was developed especially for the simple and reliable clamping of inserts during HPC machining.

The principle of form-fit and force-fit clamping allows the cutting speed and feed speed to be increased significantly.

i The IKS-PRO principle

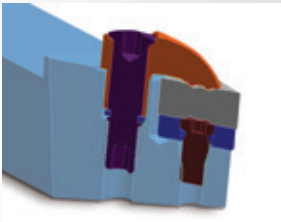

Laminar and for form-fit distributed clamping force with retraction into the insert seating



THE SYSTEM S3



The S3 tool holder and clamping system offers extreme process reliability along with minimal tool maintenance costs for cast iron machining with solid PCBN and ceramic inserts. Cast iron machining processes with long operation times and high cutting data require precision tool solutions that offer the highest level of process reliability while keep-

ing maintenance costs to a minimum. The design and the materials selected for the S3 system have been developed with precisely these requirements in mind. The S3 system's unique characteristics are a result of its innovative ODC Force clamping technology, optimised design and the use of a modern combination of materials. The optional high-

ODC force clamping technology

The S3 clamping technology ensures that the clamping force is optimally distributed so that the insert is reliably clamped as a result. Part of the clamping force is applied directly to the insert powerfully, creating a form-fit seal. Two thirds of the clamping force retracts the insert into the insert seating.



temperature-resistant material version of the insert seating prevents the insert from expanding or becoming embedded in the insert seating. This means that the workpieces can be clamped extremely securely and reliably while ensuring maximum dimensional accuracy with a long tool life.

A MIX OF CUTTING MATERIALS IS ADVANTAGEOUS

The machining of cast iron materials is influenced by a number of factors. For example, the age of the casting – the time between the casting and the machining work – has a significant influence on the tool life. This requires alternative cutting materials, which can continue to achieve the required tool life and productivity even under the changeable conditions. As a manufacturer of ceramic high-performance cutting materials, CeramTec is able to supply its customers with alternative cutting materials within a short

period of time. This applies to both inserts in standard geometries as well as to custom designs. Furthermore, IKS-PRO clamping technology allow users to switch to alternative cutting material grades within seconds without having to adjust the entire tool system. Switching from ceramic cutting materials to PCBN and back is straightforward and does not require a refitting of the tools.

CUSTOMISED SOLUTIONS



i EASY Change Technologie

EASY **CHANGE** TECHNOLOGIE

The IKS-PRO notch system allows users to switch from PCBN to ceramic cutting materials such as SiAlON without having to change the tool.

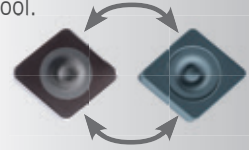

The differing size and complexity of cast components often demand sophisticated machining solutions that use special tools. Our engineering team assists customers with the goal of using as many standard tools as possible and as many special tools as required. Tool solutions are conceived for achieving optimum machining results and the highest level of efficiency. Solid, laminated and multi-tipped PCBN inserts are available for implementing customised inserts.

ZZ GEOMETRY

Every oak has been an acorn – this is probably the best way to describe the enormous increase in performance which can be achieved in finish-turning when using the ZZ geometry, also known in the industry as wiper geometry. The use of cutting inserts

with a ZZ geometry allows for significantly higher surface qualities to be achieved in comparison with inserts featuring standard geometries. Alternatively, the main machining times can be reduced considerably without any consequences to high surface quali-

ties. Therefore, the ZZ geometries represent one of the most efficient ways of increasing productivity in machining, especially in finishing operations.

i Advantages of wiper technology

ZZ GEOMETRY

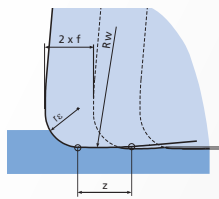

Equal feed rate
= doubled surface quality

Doubled feed rate
= machining times cut down by half



STANDARD GEOMETRY

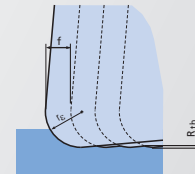

Increase in production quality

Increase in productivity

TYPES OF CUTTING EDGES

A range of different tried and tested chamfer geometries are available for the various turning tasks. The chamfer selection will not only influence the tool life, but also the surface quality and dimensional accuracy

of the workpiece. For specific applications, optimising the chamfer may cause a supplementary increase in productivity.

Finish turning of the braking surface of a brake disc using WBN 115

Machining operation: roughing, material: grey cast iron GJL 250, coolant: none

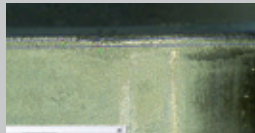

	Competition	SPK Cutting Tools
Grade:	PCBN	WBN 115
Insert:	SNGN 120416 T	SNGX 120416 T - S - DO
Cutting speed v_c :	1100 m/min	1100 m/min
Feed rate f :	0,6 mm	0,6 mm
Depth of cut a_p :	1,5 mm	1,5 mm
Tool life N:	3000 pcs	4000 pcs
Wear on the main cutting edge	0,15 mm	0,13 mm
Wear patterns		

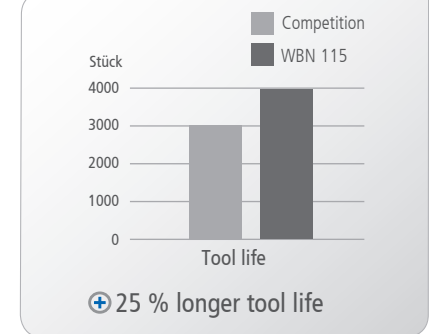
i Performance comparison



Finish turning of the connecting face of a brake disc using WBN 115

Machining operation: roughing, material: grey cast iron GJL 250, coolant: none, interrupted cut

	Competition	SPK Cutting Tools
Grade:	PCBN	WBN 115
Insert:	RNGN 120400 T	RNGX 120400 T - S - DO
Cutting speed v_c :	1100 m/min	1100 m/min
Feed rate f :	0,3 mm	0,3 mm
Depth of cut a_p :	2 mm	2 mm
Tool life N:	1500 pcs	1500 pcs
Wear on the main cutting edge	0,94 mm	0,23 mm
Wear patterns		

i Performance comparison

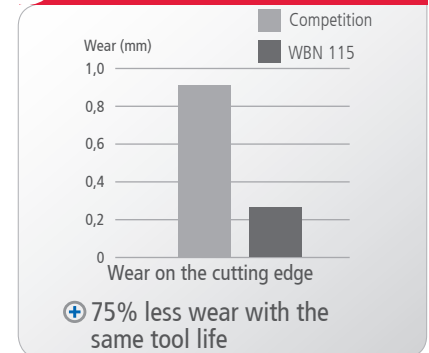



Finish turning of a brake disc with/without IKS-PRO clamping system

Machining operation: roughing, material: grey cast iron GJL 250 (GG-25), coolant: none

	Machining the inside wheel face mount		Outer diameter and facing	
	Standard	IKS-PRO	Standard	IKS-PRO
Clamping system:	Standard	IKS-PRO	Standard	IKS-PRO
Insert:	CNMN 120416 T-S	CNGX 120416 T-S-DO	SNMN 120416 T-S	SNGX 120416 T-S-DO
Cutting speed v_c :	1200 m/min	1200 m/min	1200 m/min	1200 m/min
Feed rate f :	0,35 mm	0,45 mm	0,45 mm	0,65 mm
Depth of cut a_p :	3 mm	3 mm	3 mm	3 mm
Tool life N :	1000 pcs	1250 pcs	1000 pcs	1250 pcs

i Tool life comparison in %

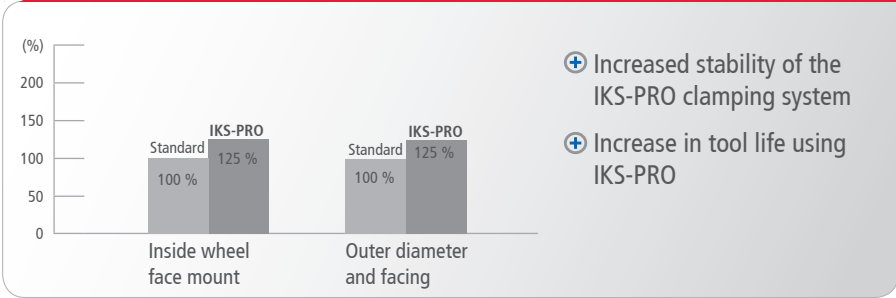

i Machining time comparison in %

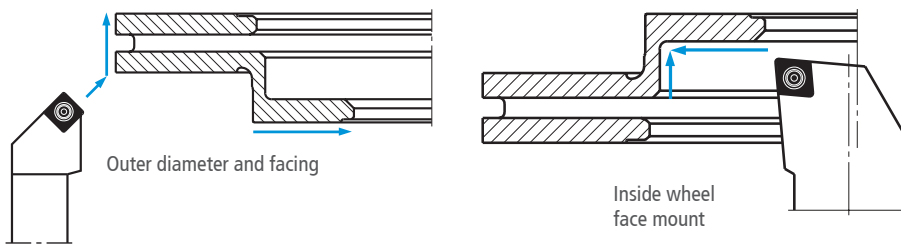
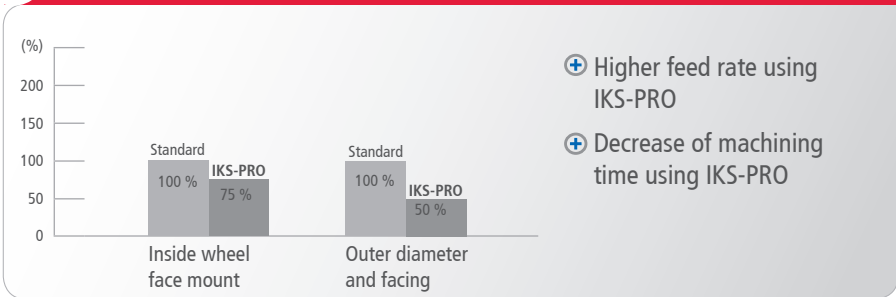



SPK PCBN inserts for cast iron machining turning



Designation system for inserts for turning for SPK-PCBN

V	35°	
D	55°	
E	75°	
C	80°	
M	86°	
K	55°	
B	82°	
A	85°	
R		
S	90°	
T	60°	
W	80°	
L		
P	108°	
H	120°	
O	135°	

Insert shape

N	0°
A	3°
B	5°
C	7°
P	11°
D	15°
E	20°
F	25°
G	30°
O	Clearance angle which requires special data.

Normal clearance angle

Inscribed circle d mm		O 135°	T 60°					W 80°	Inscribed circle d mm	
				C 80°	E 75°	D 55°	V 35°			
3,97			06					6,0	06	
5,56			09					7,0	07	
6,35			11	06		07		8,0	08	
9,52	09		16	09		11	16	06	09	
10,00						12			10	
12,70	12	05	22	12	13	15	22	08	12	
15,88	15	06	27	16					16	
19,05	19		33						20	
25,40	25		44						25	

Insert size

C

N

G

A

12

Tolerances

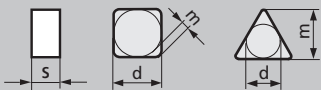

* Permissible deviations for the insert form, depending on the insert size

	S = ± mm	d = ± mm	m = ± mm	Inscribed circle d mm	Tolerance class			
					J, K, L, M	U	M, N	U
					d = ± mm		m = ± mm	
A	0,025	0,025	0,005					
C	0,025	0,025	0,013					
E	0,025	0,025	0,025					
F	0,025	0,013	0,005	3,97				
G	0,130	0,025	0,025	5,56	0,05	0,08	0,08	0,13
H	0,025	0,013	0,013	6,35				
J	0,025	0,05-0,13*	0,005	9,52				
K	0,025	0,05-0,13*	0,013	12,70	0,08	0,13	0,13	0,2
L	0,025	0,05-0,13*	0,025	15,88	0,1	0,18	0,15	0,27
M	0,130	0,05-0,13*	0,08-0,18*	19,05				
U	0,130	0,08-0,25*	0,13-0,38*	25,40	0,13	0,25	0,18	0,38

Insert type

N		T	
R		Q	
F		U	
A		B	
M		H	
G		C	
W		J	
X	Special design		

00	RN, RC	Chamfer angle		Clearance angle α_n	
M0	RB				
02	0,2				
04	0,4				
08	0,8	A	45°	N	0°
12	1,2	D	60°	C	7°
16	1,6	E	75°	P	11°
24	2,4	F	85°	D	15°
32	3,2	Z	Every other angle		
40	4,0				

Corner radius/chamfer

F		Sharp
S		Chamfered and rounded
T		Chamfered

Cutting edge design

Approach angle K_r	
75	75°
85	85°
95	95°

Approach angle ZZ geometry

Width of the ZZ chamfer	
025	0,25 mm
050	0,50 mm
075	0,75mm
100	1,0 mm

Width of the ZZ chamfer

04

08

T

-BL

95Z025

R08

Insert thickness

01	1,59
02	2,38
03	3,18
T3	3,97
04	4,76
06	6,35
07	7,94
09	9,52
12	12,7

Design variants

B		One-side multi-tipped CBN inserts, 2 corners
C		One-side multi-tipped CBN inserts, 3 corners
D		One-side multi-tipped CBN inserts, 4 corners
L		Two-side, multi-tipped CBN inserts, 4 corners
M		Two-side, multi-tipped CBN inserts, 6 corners
N		Two-side, multi-tipped CBN inserts, 8 corners
F		One-side full face laminated
S		solid CBN

Length of the CBN tip

S	$\geq 0,8 \text{ mm}$
L	$\geq 2,0 \text{ mm}$

Transition radius Chamfer

R02	0,2
R04	0,4
R08	0,8
R12	1,2
R16	1,6

SPK PCBN inserts for cast iron machining Multi-tipped

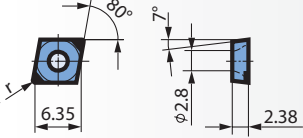
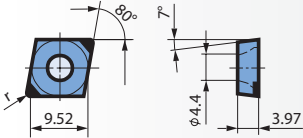
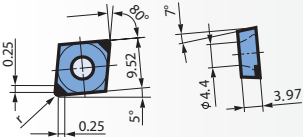
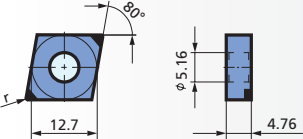
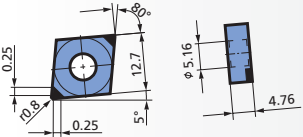
INSERT	DESIGNATION	GRADE	SPK-REF. NR.
CCGW 06 02 .. T - BL 	CCGW 06 02 04 T - BL	WBN 750	16.57.406.37.8
	CCGW 06 02 08 T - BL	WBN 750	16.57.427.37.8
CCGW 09 T3 .. T - BL 	CCGW 09 T3 04 T - BL	WBN 750	16.57.401.37.8
	CCGW 09 T3 08 T - BL	WBN 750	16.57.402.37.8
	CCGW 09 T3 12 T - BL	WBN 750	16.57.421.37.8
CCGW 09 T3 .. T - BL 95Z025 	CCGW 09 T3 08 T - BL 95Z025	WBN 750	16.57.407.37.8
	CCGW 09 T3 12 T - BL 95Z025	WBN 750	16.57.422.37.8
CNGA 12 04 .. T - BL 	CNGA 12 04 04 T - BL	WBN 750	16.56.406.37.8
	CNGA 12 04 08 T - BL	WBN 750	16.56.407.37.8
	CNGA 12 04 12 T - BL	WBN 750	16.56.408.37.8
CNGA 12 04 08 T - BL - 95Z025 	CNGA 12 04 08 T - BL 95Z025	WBN 750	16.54.429.37.8

SPK PCBN inserts for cast iron machining Multi-tipped

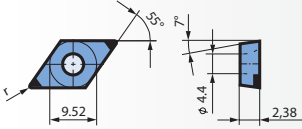
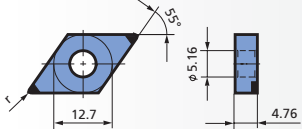
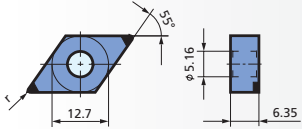
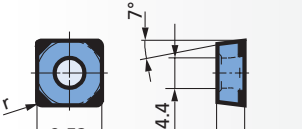
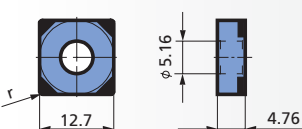
INSERT	DESIGNATION	GRADE	SPK-REF. NR.
DCGW 07 02 .. T - BL 	DCGW 07 02 02 T - BL	WBN 750	16.57.426.37.8
	DCGW 07 02 04 T - BL	WBN 750	16.57.410.37.8
	DCGW 07 02 08 T - BL	WBN 750	16.57.411.37.8
DNGA 15 04 .. T - BL 	DNGA 15 04 04 T - BL	WBN 750	16.56.401.37.8
	DNGA 15 04 08 T - BL	WBN 750	16.56.402.37.8
	DNGA 15 04 12 T - BL	WBN 750	16.56.432.69.8
DNGA 15 06 .. T - BL 	DNGA 15 06 04 T - BL	WBN 750	16.56.403.37.8
	DNGA 15 06 08 T - BL	WBN 750	16.56.405.37.8
	DNGA 15 06 12 T - BL	WBN 750	16.56.411.37.8
SCGW 09 T3 .. T - DL 	SCGW 09 T3 04 T - DL	WBN 750	16.17.419.37.8
	SCGW 09 T3 08 T - DL	WBN 750	16.17.420.37.8
SNGA 12 04 .. T - DL 	SNGA 12 04 04 T - DL	WBN 750	16.16.401.37.8
	SNGA 12 04 08 T - DL	WBN 750	16.16.402.37.8
	SNGA 12 04 12 T - DL	WBN 750	16.16.403.37.8

SPK PCBN inserts for cast iron machining

Multi-tipped

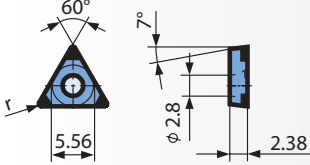
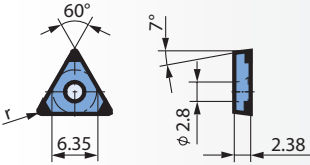
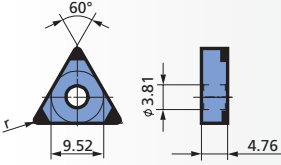
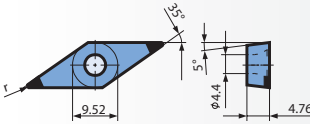
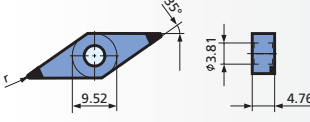
INSERT	DESIGNATION	GRADE	SPK-REF. NR.
TCGW 09 02 04 T - CL 	TCGW 09 02 04 T - CL	WBN 750	16.37.405.37.8
TCGW 11 02 .. T - CL 	TCGW 11 02 04 T - CL	WBN 750	16.37.403.37.8
	TCGW 11 02 08 T - CL	WBN 750	16.37.404.37.8
TNGA 16 04 .. - CL 	TNGA 16 04 04 T - CL	WBN 750	16.36.401.37.8
	TNGA 16 04 08 T - CL	WBN 750	16.36.402.37.8
	TNGA 16 04 12 T - CL	WBN 750	16.36.403.37.8
	TNGA 16 04 16 F - CL	WBN 750	16.36.404.06.8
VBGW 16 04 .. T - BL 	VBGW 16 04 02 T - BL	WBN 750	16.57.423.37.8
	VBGW 16 04 04 T - BL	WBN 750	16.57.412.37.8
	VBGW 16 04 08 T - BL	WBN 750	16.57.413.37.8
	VBGW 16 04 12 T - BL	WBN 750	16.57.414.37.8
VNGA 16 04 .. T - BL 	VNGA 16 04 04 T - BL	WBN 750	16.56.409.37.8
	VNGA 16 04 08 T - BL	WBN 750	16.56.410.37.8
	VNGA 16 04 16 T - BL	WBN 750	16.56.420.68.8

SPK PCBN inserts for cast iron machining Laminated

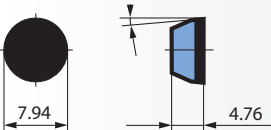
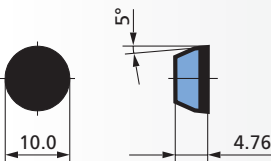
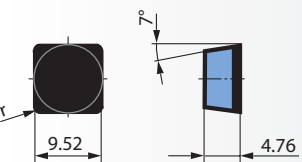
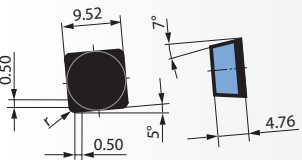
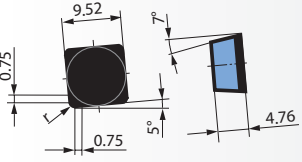
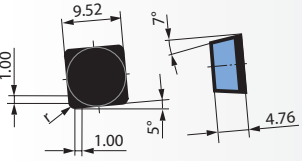
INSERT	DESIGNATION	GRADE	SPK-REF. NR.
RBGN 08 04 M0 	RBGN 08 04 M0 S - F	WBN 750	16.41.241.34.8
	RBGN 08 04 M0 T - F	WBN 750	16.41.241.37.8
	RBGN 08 04 M0 T - F	WBN 750	16.41.241.43.8
RBGN 10 04 M0 - F 	RBGN 10 04 M0 T - F	WBN 750	16.41.242.37.8
	RBGN 10 04 M0 E - F	WBN 750	16.41.242.43.8
SCGN 09 04 .. - F 	SCGN 09 04 08 T - F	WBN 750	16.13.206.37.8
	SCGN 09 04 12 E - F	WBN 750	16.13.207.43.8
	SCGN 09 04 08 F - F	WBN 750	16.13.207.06.8
SCGN 09 04 .. - F 85Z050 	SCGN 09 04 08 T - F 85Z050	WBN 750	16.13.236.71.8
	SCGN 09 04 12 T - F 85Z050	WBN 750	16.13.229.68.8
SCGN 09 04 08 - F 85Z075 	SCGN 09 04 08 E - F 85Z075	WBN 750	16.13.210.69.8
SCGN 09 04 08 - F 85Z100 	SCGN 09 04 08 S - F 85Z100	WBN 750	16.13.218.45.8

SPK PCBN inserts for cast iron machining

Solid

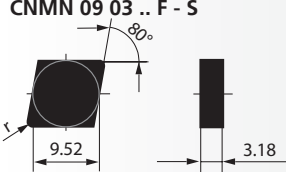
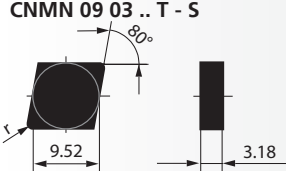
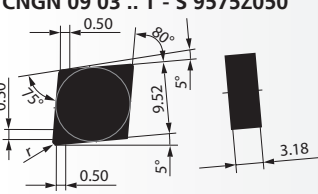
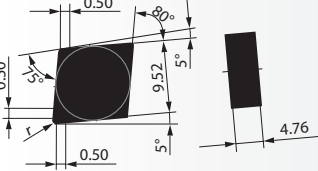
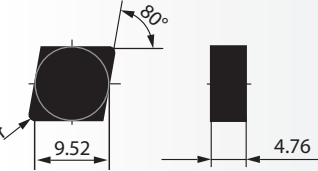
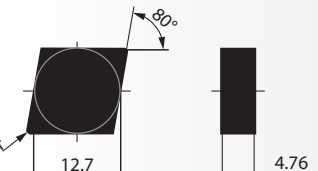
INSERT	DESIGNATION	GRADE	SPK REF. NO.
CNMN 09 03 .. F - S 	CNMN 09 03 08 F - S	WBN 120	20.50.012.06.2
	CNMN 09 03 16 F - S	WBN 115	12.50.014.04.0
CNMN 09 03 .. T - S 	CNMN 09 03 08 T - S	WBN 101	20.50.012.04.1
	CNMN 09 03 12 T - S	WBN 101	20.50.013.04.1
	CNMN 09 03 16 T - S	WBN 101	20.50.014.04.1
CNGN 09 03 .. T - S 9575Z050 	CNGN 09 03 12 T - S 9575Z050	WBN 115	12.52.073.03.0
CNGN 09 04 .. T - S 9575Z050 	CNGN 09 04 08 T - S 9575Z050	WBN 115	12.52.075.03.0
CN.N 09 04 .. T - S 	CNMN 09 04 08 T - S	WBN 115	12.50.061.68.0
	CNMN 09 04 12 T - S	WBN 115	12.50.062.68.0
	CNGN 09 04 16 T - S	WBN 115	12.52.045.68.0
	CNMN 09 04 16 T - S	WBN 115	12.50.059.68.0
		WBN 120	20.50.059.04.2
CNMN 12 04 .. T - S 	CNMN 12 04 08 T - S	WBN 115	12.50.027.68.0
		WBN 101	20.50.027.04.1
	CNMN 12 04 12 T - S	WBN 115	12.50.028.68.0
		WBN 101	20.50.028.04.1
	CNMN 12 04 16 T - S	WBN 115	12.50.029.68.0
		WBN 120	20.50.029.04.2
	WBN 101	20.50.029.04.1	

SPK PCBN inserts for cast iron machining Solid

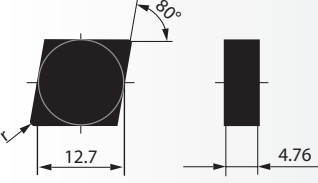
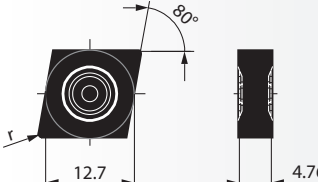
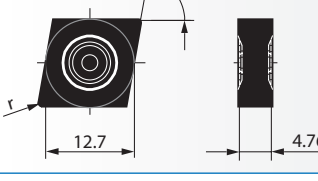
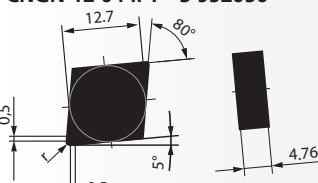
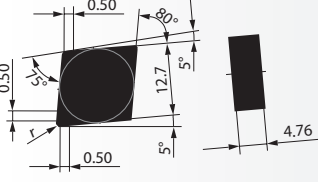
INSERT	DESIGNATION	GRADE	SPK REF. NO.
CNMN 12 04 .. - S 	CNMN 12 04 08 T - S	WBN 115	12.50.027.03.0
	CNMN 12 04 12 S - S	WBN 115	12.50.028.55.0
		WBN 101	20.50.028.47.1
	CNMN 12 04 16 S - S	WBN 115	12.50.029.34.0
		WBN 101	20.50.029.71.1
	CNMN 12 04 16 T - S	WBN 115	12.50.029.54.0
CNMX 12 04 .. S - S - DO 	CNMX 12 04 12 S - S - DO	WBN 101	20.50.067.47.1
	CNMX 12 04 16 S - S - DO	WBN 101	20.50.068.71.1
CNMX 12 04 .. T - S - DO 	CNMX 12 04 08 T - S - DO	WBN 101	20.50.066.04.1
	CNMX 12 04 12 T - S - DO	WBN 101	20.50.067.04.1
	CNMX 12 04 16 T - S - DO	WBN 101	20.50.068.04.1
CNGN 12 04 .. T - S 95Z050 	CNGN 12 04 08 T - S 95Z050	WBN 115	12.52.077.03.0
	CNGN 12 04 12 T - S 95Z050	WBN 115	12.52.057.03.0
CNGN 12 04 .. T - S 9575Z050 	CNGN 12 04 08 T - S 9575Z050	WBN 115	12.52.078.03.0
	CNGN 12 04 12 T - S 9575Z050	WBN 115	12.52.076.03.0

SPK PCBN inserts for cast iron machining

Solid

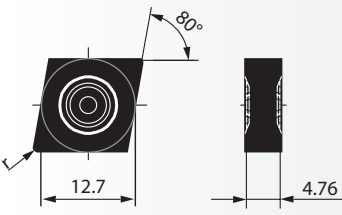
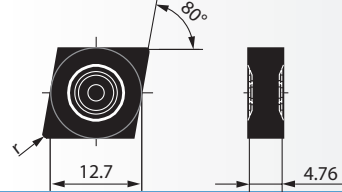
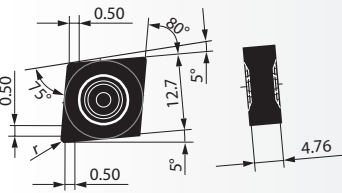
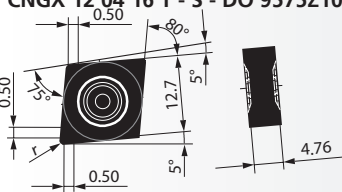
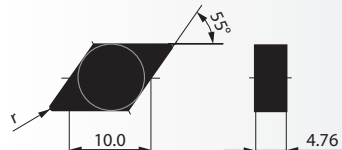
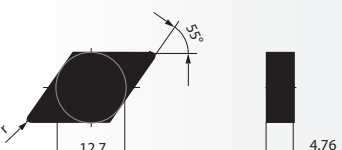



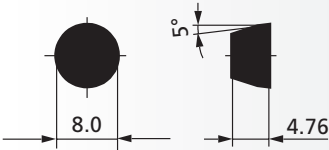
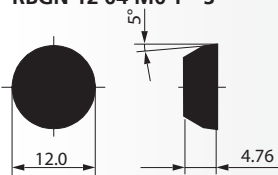
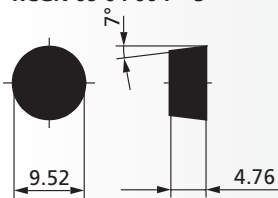
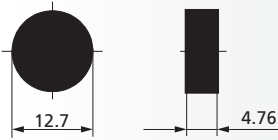
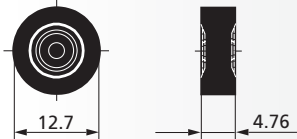

INSERT	DESIGNATION	GRADE	SPK REF. NO.
CNGX 12 04 .. T - S - DO 	CNGX 12 04 08 T - S - DO	WBN 115	12.52.016.68.0
	CNGX 12 04 12 T - S - DO	WBN 115	12.52.017.68.0
	CNGX 12 04 16 T - S - DO	WBN 115	12.52.018.68.0
		WBN 120	20.52.018.04.2
	CNGX 12 04 32 T - S - DO	WBN 115	12.52.054.04.0
		WBN 120	20.52.054.04.2
CNGX 12 04 .. S - S - DO 	CNGX 12 04 12 S - S - DO	WBN 115	12.52.017.55.0
	CNGX 12 04 16 S - S - DO	WBN 115	12.52.018.71.0
CNGX 12 04 16 T - S - DO 9575Z050 	CNGX 12 04 16 T - S - DO 9575Z050	WBN 115	12.52.041.68.0
		WBN 120	20.52.041.68.2
CNGX 12 04 16 T - S - DO 9575Z100 	CNGX 12 04 16 T - S - DO 9575Z100	WBN 115	12.52.079.68.0
DN . N 12 04 .. T - S 	DNGN 12 04 04 T - S	WBN 120	20.50.054.04.2
	DNMN 12 04 08 T - S	WBN 115	12.50.055.04.0
	DNMN 12 04 12 T - S	WBN 115	12.50.056.68.0
		WBN 120	20.50.056.04.2
	DNMN 12 04 16 T - S	WBN 115	12.50.057.68.0
	WBN 120	20.50.057.04.2	
DNMN 15 04 .. S - S 	DNMN 15 04 08 S - S	WBN 101	20.50.037.73.1
	DNMN 15 04 12 S - S	WBN 101	20.50.038.73.1
	DNMN 15 04 16 S - S	WBN 101	20.50.039.73.1

SPK PCBN inserts for cast iron machining Solid

INSERT	DESIGNATION	GRADE	SPK REF. NO.
RBGN 08 04 M0 T - S 	RBGN 08 04 M0 T - S	WBN 115	12.41.003.68.0
RBGN 12 04 M0 T - S 	RBGN 12 04 M0 T - S	WBN 101	20.41.006.04.1
RCGN 09 04 00 F - S 	RCGN 09 04 00 F - S	WBN 115	12.43.005.06.0
		WBN 120	20.43.005.06.2
RNGN 12 04 00 . - S 	RNGN 12 04 00 S - S	WBN 101	20.42.010.46.1
	RNGN 12 04 00 T - S	WBN 101	20.42.010.04.1
RNGX 12 04 00 .. - S - DO 	RNGX 12 04 00 T - S - DO	WBN 115	12.42.002.68.0
	RNGX 12 04 00 F - S - DO	WBN 120	20.42.002.06.2

SPK PCBN inserts for cast iron machining

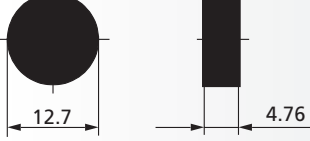
Solid

INSERT	DESIGNATION	GRADE	SPK REF. NO.
RNMN 09 03 00 T - S 	RNMN 09 03 00 T - S	WBN 101	20.40.004.04.1
RNMN 12 03 00 . - S 	RNMN 12 03 00 S - S	WBN 101	20.40.006.46.1
	RNMN 12 03 00 T - S	WBN 101	20.40.006.04.1
RNMN 09 04 00 T - S 	RNMN 09 04 00 T - S	WBN 115	12.40.014.68.0
		WBN 120	20.40.014.68.2
RNMN 12 04 00 E - S 	RNMN 12 04 00 E - S	WBN 101	20.40.015.40.1
RNMN 12 04 00 T - S 	RNMN 12 04 00 T - S	WBN 115	12.40.015.68.0
		WBN 120	20.40.015.04.2
		WBN 101	20.40.015.10.1
		WBN 101	20.40.015.04.1
RNMN 12 04 00 S - S 	RNMN 12 04 00 S - S	WBN 101	20.40.015.71.1

SPK PCBN inserts for cast iron machining Solid

INSERT	DESIGNATION	GRADE	SPK REF. NO.
<p>SCGN 09 04 AC T - S 85Z050 R08</p>	SCGN 09 04 AC T - S 85Z050 R08	WBN 101	20.13.013.03.1
<p>SCGN 09 04 12 F - S 85Z025</p>	SCGN 09 04 12 F - S 85Z025	WBN 115 WBN 120	12.13.047.06.0 20.13.047.06.2
<p>SCGN 09 04 07 T - S 85Z100</p>	SCGN 09 04 07 T - S 85Z100	WBN 115	12.13.049.68.0
<p>SCGN 09 04 08 T - S 85Z050</p>	SCGN 09 04 08 T - S 85Z050	WBN 115 WBN 115 WBN 101	12.13.034.68.0 12.13.034.99.0 20.13.034.68.1
<p>SCGN 09 04 08 T - S 85Z075</p>	SCGN 09 04 08 T - S 85Z075	WBN 120	20.13.043.04.2
<p>SCGN 09 04 08 T - S 85Z100</p>	SCGN 09 04 08 T - S 85Z100	WBN 115	12.13.036.68.0

SPK PCBN inserts for cast iron machining Solid

INSERT	DESIGNATION	GRADE	SPK REF. NO.
<p>SCGN 09 04 AC T - S 85Z100 R08</p>	SCGN 09 04 AC T - S 85Z100 R08	WBN 115	12.13.046.68.0
<p>SNGN 09 04 08 T - S 85Z050</p>	SNGN 09 04 08 T - S 85Z050	WBN 115 WBN 101	12.12.063.68.0 20.12.053.03.1
<p>SNGN 09 04 08 T - S 85Z075</p>	SNGN 09 04 08 T - S 85Z075	WBN 115 WBN 120	12.12.064.68.0 20.12.064.04.2
<p>SNGN 09 04 AN T - S 85Z050 R08</p>	SNGN 09 04 AN T - S 85Z050 R08	WBN 115	12.13.045.68.0
<p>SNGN 09 04 AN T - S 85Z050 R08</p>	SNGN 09 04 AN T - S 85Z050 R08	WBN 115	12.13.046.68.0

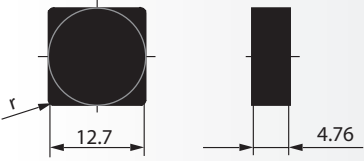
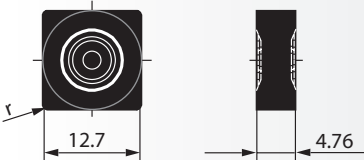
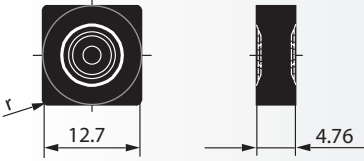
INSERT	DESIGNATION	GRADE	SPK REF. NO.
<p>SNGN 12 04 16 T - S</p> 	SNGN 12 04 16 T - S	WBN 101	20.12.022.03.1
<p>SNGX 12 04 12 S - S DO</p> 	SNGX 12 04 12 S - S DO	WBN 101	20.12.046.71.1
<p>SNGX 12 04 ... - S - DO</p> 	SNGX 12 04 08 T - S - DO	WBN 115	12.12.045.68.0
	SNGX 12 04 12 S - S - DO	WBN 115	12.12.046.55.0
		WBN 101	20.12.046.71.1
	SNGX 12 04 12 T - S - DO	WBN 115	12.12.046.68.0
		WBN 120	20.12.046.04.2
	SNGX 12 04 16 S - S - DO	WBN 115	12.12.047.71.0
		WBN 101	20.12.047.47.1
	SNGX 12 04 16 T - S - DO	WBN 115	12.12.047.68.0
	WBN 120	20.12.047.04.2	

SPK PCBN inserts for cast iron machining

Solid

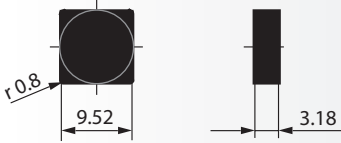
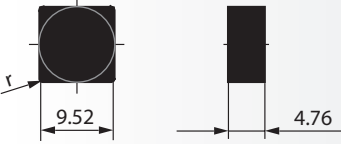
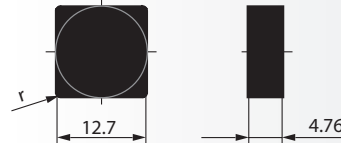
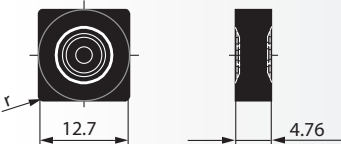
INSERT	DESIGNATION	GRADE	SPK REF. NO.
SNMN 09 03 ... - S 	SNMN 09 03 08 F - S	WBN 101	20.10.003.06.1
	SNMN 09 03 08 T - S	WBN 101	20.10.003.03.1
SNMN 09 04 .. T - S 	SNMN 09 04 08 T - S	WBN 115	12.10.021.68.0
	SNMN 09 04 12 T - S	WBN 115	12.10.022.68.0
	SNMN 09 04 16 T - S	WBN 115	12.10.023.68.0
		WBN 120	20.10.023.04.2
SNMN 12 04 .. - S 	SNMN 12 04 08 T - S	WBN 115	12.10.029.68.0
	SNMN 12 04 12 T - S	WBN 115	12.10.030.68.0
	SNMN 12 04 12 E - S	WBN 115	12.10.030.43.0
	SNMN 12 04 12 S - S	WBN 115	12.10.030.55.0
	SNMN 12 04 16 T - S	WBN 115	12.10.031.68.0
		WBN 120	20.10.031.04.2
	SNMN 12 04 16 S - S	WBN 101	20.10.031.34.1
	SNMN 12 04 16 T - S	WBN 101	20.10.031.04.1
	SNMN 12 04 30 S - S	WBN 101	20.10.034.34.1
	SNMX 12 04 ... - S - DO 	SNMX 12 04 08 T - S - DO	WBN 101
SNMX 12 04 12 S - S - DO		WBN 101	20.10.038.04.1
SNMX 12 04 16 S - S - DO		WBN 101	20.10.039.71.1
SNMX 12 04 16 T - S - DO		WBN 101	20.10.039.04.1



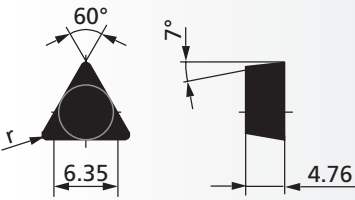
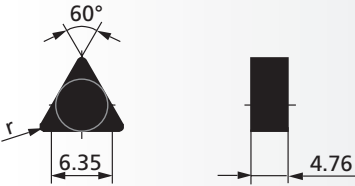
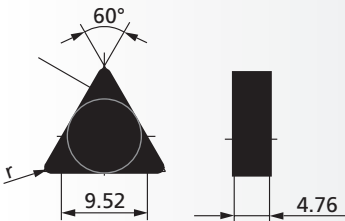
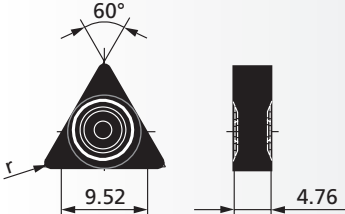

SPK PCBN inserts for cast iron machining Solid

INSERT	DESIGNATION	GRADE	SPK REF. NO.
TCMN 11 04 16 T - S 	TCMN 11 04 16 T - S	WBN 115	12.31.003.68.0
TNMN 11 04 16 .. - S 	TNMN 11 04 16 T - S	WBN 115	12.30.023.68.0
	TNMN 11 04 16 S - S	WBN 115	12.30.023.73.0
TNMN 16 04 16 T - S 	TNMN 16 04 16 T - S	WBN 115	12.30.032.68.0
		WBN 120	20.30.032.04.2
TNGX 16 04 16 T - S - DO 	TNGX 16 04 16 T - S - DO	WBN 115	12.32.032.68.0



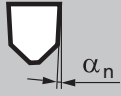

Designation system for inserts for grooving for SPK-PCBN

G  Single-edge		P 																											
L  Double-edge	<table border="1"> <tr><td>N</td><td>0°</td></tr> <tr><td>A</td><td>3°</td></tr> <tr><td>B</td><td>5°</td></tr> <tr><td>C</td><td>7°</td></tr> <tr><td>P</td><td>11°</td></tr> <tr><td>O</td><td>Clearance angle which requires special data.</td></tr> </table>	N	0°	A	3°	B	5°	C	7°	P	11°	O	Clearance angle which requires special data.	X Specialdesign	<table border="1"> <tr><td>A</td><td>≤ 5 mm</td></tr> <tr><td>B</td><td>≤ 5,5 mm</td></tr> <tr><td>C</td><td>≤ 6 mm</td></tr> <tr><td>D</td><td>≤ 6,5 mm</td></tr> <tr><td>E</td><td>≤ 7,5 mm</td></tr> <tr><td>F</td><td>≤ 8 mm</td></tr> <tr><td>G</td><td>≤ 10 mm</td></tr> </table>	A	≤ 5 mm	B	≤ 5,5 mm	C	≤ 6 mm	D	≤ 6,5 mm	E	≤ 7,5 mm	F	≤ 8 mm	G	≤ 10 mm
N	0°																												
A	3°																												
B	5°																												
C	7°																												
P	11°																												
O	Clearance angle which requires special data.																												
A	≤ 5 mm																												
B	≤ 5,5 mm																												
C	≤ 6 mm																												
D	≤ 6,5 mm																												
E	≤ 7,5 mm																												
F	≤ 8 mm																												
G	≤ 10 mm																												
Insert shape	Normal setting angle	Insert type	Insert thickness																										
G	B	M	P	12	A																								

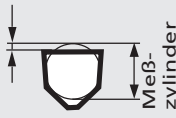
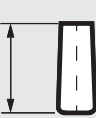
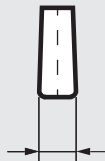
Tolerance			Insert size	
	Height	Length	Groove width	
				
M	± 0,13 mm	± 0,1 mm	12	12,0 mm
			15	15,0 mm

F 
Sharp

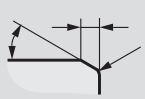
S 
Chamfered and rounded

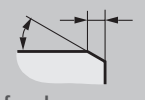
T 
Chamfered

Cutting edge design

R 

L 

N 

Cutting direction

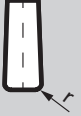

Radius left		Radius right	
L0.8	r=0,8mm	R0.8	r=0,8mm
L1.5	r=1,5mm	R1.5	r=1,5mm
L2	r=2,0mm	R2	r=2,0mm
..

Cutting edge radius

0400 **T** **-S** **-N** **L2R2** **-RAG**

Groove width

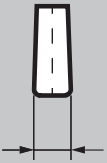

0400	4 mm
0500	5 mm
0600	6 mm
0700	7 mm
0800	8 mm
0900	9 mm
..	..

CBN design

F	flächig belegt	
S	solid CBN	

Type Grooving system

SPK-PCBN inserts for grooving Laminated

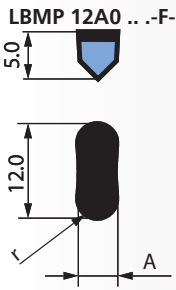
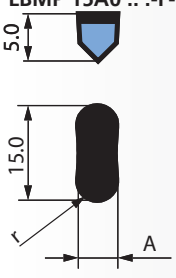
INSERT	DESIGNATION	GRADE	SPK REF. NO.	
LBMP 12A0 ...-F-N.. 	LBMP 12A029 T-F-N L1.45 R1.45	WBN 750	16.78.235.03.8	
	LBMP 12A029 S-F-N L1.45 R1.45	WBN 750	16.78.034.03.8	
	LBMP 12A040 T-F-N L2 R2	WBN 750	16.78.206.03.8	
	LBMP 12A050 T-F-N L2.5 R2.5	WBN 750	16.78.234.03.8	
	LBMP 12A060 T-F-N L1.5 R1.5	WBN 750	16.78.246.03.8	
	LBMP 12A060 T-F-N L3 R3	WBN 750	16.78.245.03.8	
	LBMP 12A090 T-F-N L0.8 R0.8	WBN 750	16.78.253.03.8	
LBMP 15A0 ...-F-N.. 	LBMP 15A0785 T-F-N L2.55 R2.55	WBN 750	16.78.236.03.8	

SPK-PCBN inserts for grooving RAG Solid

INSERT	DESIGNATION	GRADE	SPK REF. NO.
GBMP 12A0... T-S-N .. -RAG 	GBMP 12A0500 T-S-N L2.5 R2.5 -RAG	WBN 115	12.78.062.03.0
GBMP 12A0... T-S-N .. -RAG 	GBMP 12A0600 T-S-N L3 R3 -RAG	WBN 115	12.78.063.03.0
LBMP 12A0 ... T-S-N.. -RAG 	LBMP 12A0400 T-S-N L2 R2 -RAG	WBN 115	12.78.070.03.0
LBMP 12A0 ... T-S-N.. -RAG 	LBMP 12A0700 T-S-N L1.6 R1.6 -RAG	WBN 115	12.78.080.03.0
	LBMP 12A0700 T-S-N L2.5 R2.5 -RAG	WBN 115	12.78.083.03.0
LBMP 12A0 ... T-S-N.. -RAG 	LBMP 12A0700 T-S-N L3.5 R3.5 -RAG	WBN 115	12.78.073.03.0





Designation system for inserts for milling according to ISO 1832

R		
S	90°	
T	60°	
H	120°	
O	135°	

Insert shape

N	0°
A	3°
B	5°
C	7°
P	11°
D	15°
E	20°
F	25°
G	30°
O	Clearance angle which requires special data.

Normal setting angle

Inscribed circle					
d mm	H 120°	O 135°	RC, RN	S 90°	T 60°
3,97					06
5,56					09
6,35					11
9,52			09	09	16
12,70			12	12	22
13,50		05		13	
15,88	09		15	15	27
16,20	10				
16,50		06			
19,05			19	19	33
25,40			25	25	44

Insert size

S

N

C

N

12

04

Tolerances

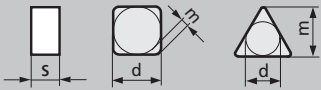

* Permissible deviations for the insert form, depending on the insert size

	S = ± mm	d = ± mm	m = ± mm	Inscribed circle	Tolerance class			
					d mm	J, K, L, M	U	M, N
					d = ± mm		m = ± mm	
A	0,025	0,025	0,005	3,97	0,05	0,08	0,08	0,13
C	0,025	0,025	0,013					
E	0,025	0,025	0,025	5,56	0,05	0,08	0,08	0,13
F	0,025	0,013	0,005					
G	0,130	0,025	0,025	6,35	0,08	0,13	0,13	0,2
H	0,025	0,013	0,013					
J	0,025	0,05-0,13*	0,005	9,52	0,1	0,18	0,15	0,27
K	0,025	0,05-0,13*	0,013					
L	0,025	0,05-0,13*	0,025	12,70	0,13	0,25	0,18	0,38
M	0,130	0,05-0,13*	0,08-0,18*					
U	0,130	0,08-0,25*	0,13-0,38*	19,05				
				25,40				

Insert type

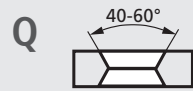
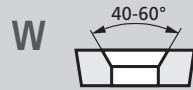
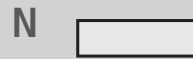

X Special design

Insert thickness

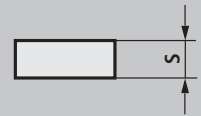

01	1,59
02	2,38
03	3,18
T3	3,97
04	4,76
05	5,56
06	6,35
07	7,94
09	9,52
12	12,70

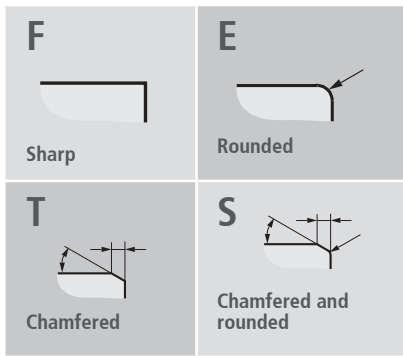

Cutting edge design

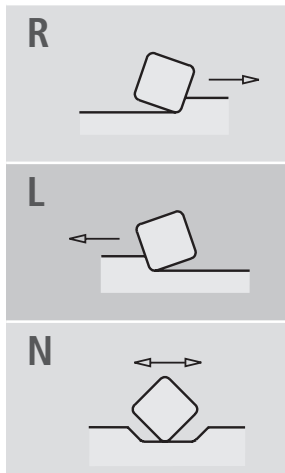

Cutting direction

Approach angle K_r	Width of the ZZ chamfer
43 = 43°	125 = 1,25 mm
47 = 47°	150 = 1,50 mm
75 = 75°	240 = 2,40 mm
88 = 88°	

Designation key for ZZ geometries

AN

T

N

01020

S

88Z240

Cutting edge radius

Insert with edge radius



Insert with face cutting edge

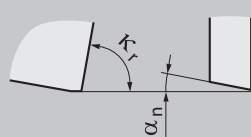

	RN, RC	Approach angle of the main cutting edge K_r	Clearance angle α_n		
	RB				
M0	RB				
02	0,2				
04	0,4				
08	0,8	A	45°	N	0°
12	1,2	D	60°	C	7°
16	1,6	E	75°	P	11°
24	2,4	F	85°	D	15°
32	3,2	P	90°	E	20°
40	4,0	Z	other angles	F	25°

Chamfer design

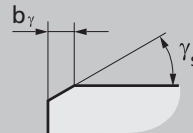

Chamfer width w_γ in 1/100 mm and angle γ_s without degree symbol

e.g.
0,10 x 20° = 01020
0,05 x 20° = 00520

CBN design

S

solid CBN

SPK-PCBN inserts for milling Solid

INSERT	DESIGNATION	GRADE	SPK REF. NO.
HNGN 09 04 16 T01020 - S 47Z125 	HNGN 09 04 16 T01020 - S 47Z125	WBN 101	20.62.011.20.1
SNGN 12 04 ZN T - S 88Z300 	SNGN 12 04 ZN T01015 - S 88Z300	WBN 101	20.12.085.37.1
	SNGN 12 04 ZN T01015 - S 88Z300	WBN 115	12.12.085.37.0
SNMN 09 04 08 T - S 	SNMN 09 04 08 T00520 - S	WBN 101	20.10.021.03.1
SNMN 12 04 .. T - S 	SNMN 12 04 08 T02020 - S	WBN 101	20.10.029.04.1
	SNMN 12 04 12 T02020 - S	WBN 101	20.10.030.04.1
TNGN 16 04 16 T00520 	TNGN 16 04 16 T00520	WBN 101	20.30.016.03.1





Notes



A series of horizontal dotted lines spanning the width of the page, intended for taking notes.



Notes

A series of horizontal dotted lines for taking notes.

www.tools-for-productivity.com

CeramTec
THE CERAMIC EXPERTS

CeramTec GmbH

SPK Cutting Tool Division
Hauptstraße 56
73061 Ebersbach / Fils
Germany

Phone: +49 7163 166-239
Fax: +49 7163 166-388
info@spk-tools.com
www.spk-tools.com / www.ceramtec.com